

Art. Nr.: CTB 51.35 CTB 51.35



Dimensions:

Bus bar 1 in mm:	50x12
Bus bar 2 in mm:	40x30
Round conductor in mm:	44
Width in mm:	85
Height in mm:	105
Depth in mm:	52

Technical Data:

Therm. nominal continuous current I_{cth} :	$1,2 \times I_{pr}$
Therm. nominal short-time current I_{th} :	$60 \times I_{pr}$, 1 Sek., max 100 kA
Max. operating voltage U_m :	1,2 kV
Isolation test voltage:	6 kV, U_{eff} , 50 Hz, 1 Min.
Nominal rated frequency:	50 Hz
Isolation class:	B

General Technical Data:

Over-current limiting factor:	See rating plate
Working temperature range:	$-5^{\circ}\text{C} < T < +50^{\circ}\text{C}$
Storage temperature range:	$-25^{\circ}\text{C} < T < +70^{\circ}\text{C}$
Custom tariff number	85043129
Applied standards 1	DIN EN 61869-1/2
Applied standards 2	DIN EN 42600-1/2
UL certificated:	Certificate Number - 20100426-E336996

Technical Drawing:

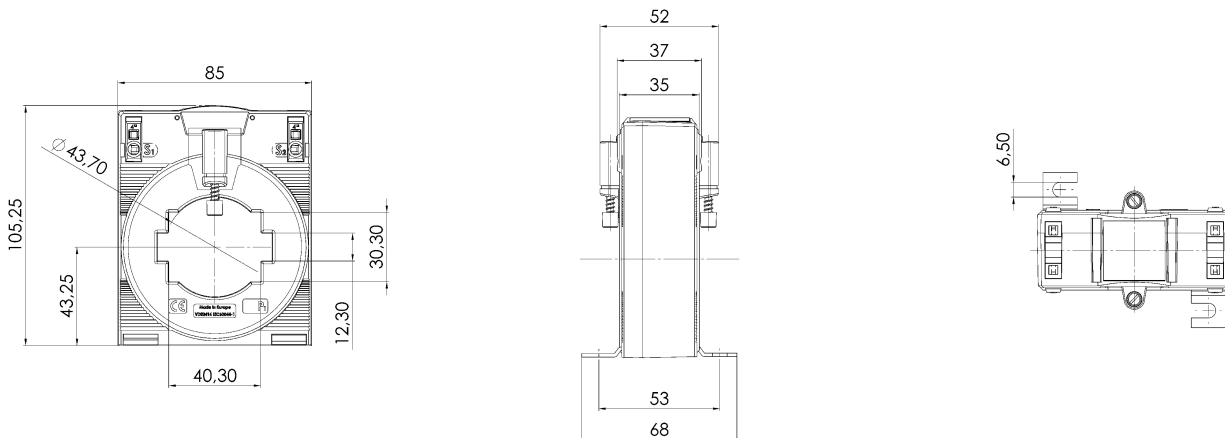

Contact:

MBS AG - Eisbachstrasse 51 - D-74429 Sulzbach-Laufen - www.mbs-ag.com
Tel.: +49 7976 9851-0 - Telefax: +49 7976 9851-90 - verkauf@mbs-ag.com

Date: 21.11.2024