



# Art. Nr.: 13041 ASK 41.4



Primary Current:	80
Secondary Current:	5
Burden (VA):	1,5
Accuracy Class:	1

### Dimensions:

Bus bar 1 in mm:	40x10
Bus bar 2 in mm:	2x30x5
Round conductor in mm:	32
Width in mm:	70
Height in mm:	88,5
Depth in mm:	58

### Technical Data:

Therm. nominal continuous current $I_{cth}$ :	$1,0 \times I_{pr}$
Therm. nominal short-time current $I_{th}$ :	$60 \times I_{pr}$ , 1 Sek.
Max. operating voltage $U_m$ :	0,72 kV
Isolation test voltage:	3 kV, $U_{eff}$ , 50 Hz, 1 Min.
Nominal rated frequency:	50/60 Hz
Isolation class:	E

### General Technical Data:

Over-current limiting factor:	See rating plate
Working temperature range:	$-5^{\circ}\text{C} < T < +50^{\circ}\text{C}$
Storage temperature range:	$-25^{\circ}\text{C} < T < +70^{\circ}\text{C}$
Unbreakable plastic housing made of black polycarbonate	Flame resistant, ultrasonically welded
Nickel-plated secondary terminals with plus-minus nickel-plated screws	M5x10mm
Custom tariff number	85043129
Applied standards 1	DIN EN 61869-1/2
Applied standards 2	DIN EN 42600-1/2

### Technical Drawing:

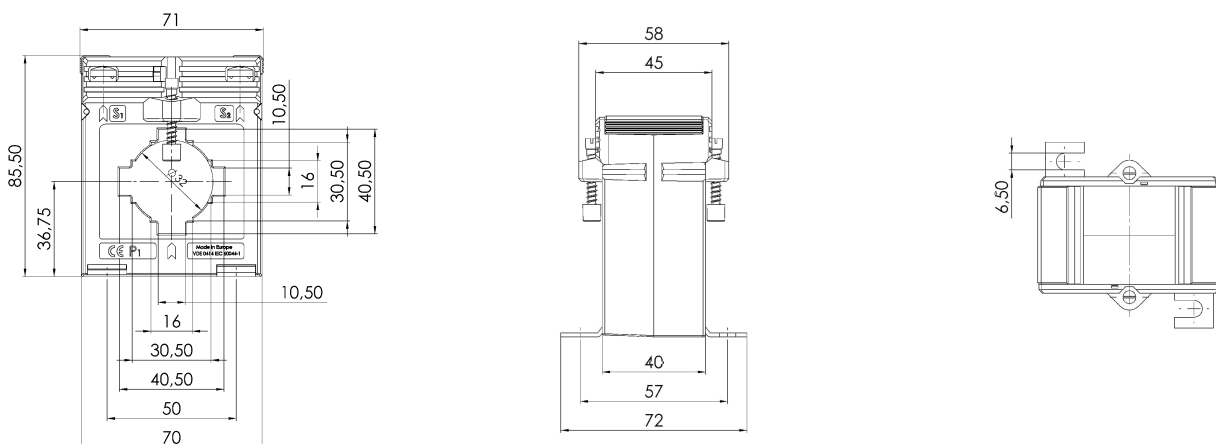



---

**Contact:**

MBS AG & Co. KG - Eisbachstrasse 51 - D-74429 Sulzbach-Laufen - [www.mbs-ag.com](http://www.mbs-ag.com)  
Tel.: +49 7976 9851-0 - Telefax: +49 7976 9851-90 - [verkauf@mbs-ag.com](mailto:verkauf@mbs-ag.com)

Date: 05.04.2026