

Energie. Zuverlässig. Messen.



# Niederspannungs Stromwandler

## 30 mm Bautiefe



## Allgemeine technische Angaben:

<b>Bemessungsfrequenz</b>	50 (60) Hz (16 2/3 bis 400 Hz auf Anfrage)
<b>Höchste Spannung für Betriebsmittel</b>	$U_m \leq 0,72 \text{ kV}$ $U_m \leq 1,2 \text{ kV}$
<b>Isolierstoffklasse</b>	F, E (auf Anfrage)
<b>Isolationsprüfspannung</b>	3 kV, 1 min., $U_{eff}$ 50 Hz ( $U_m \leq 0,72 \text{ kV}$ ) 6 kV, 1 min., $U_{eff}$ 50 Hz ( $U_m \leq 1,2 \text{ kV}$ )
<b>Thermischer Bemessungsdauerstrom</b>	$I_{CTH} = 1,2 \times I_{pr} / 1,0 \times I_{pr}$ (ab 2.000A)
	$I_{th} = 60 \times I_{pr}$ 1 sek. (max. 100 kA)
<b>Bemessungs-Stoßstrom</b>	$I_{dyn} = 2,5 \times I_{th}$
<b>Überstrom-Begrenzungsfaktor</b>	FS 5 bis FS 10 (genaue Angaben siehe Leistungsschild)
<b>Arbeitstemperaturbereich</b>	$-5^\circ\text{C} \leq \vartheta \leq +40^\circ\text{C}$
<b>Lagertemperaturbereich</b>	$-25^\circ\text{C} \leq \vartheta \leq +70^\circ\text{C}$
<b>Angewendete Normen</b>	DIN EN 61869/1+2 DIN 42600-1 Ausgabe 08/1973 DIN 42600-2 Ausgabe 05/1983

Die Installation von Stromwandlern und der daran anzuschließenden Messgeräte darf **nur im spannungslosen** Zustand der Anlage erfolgen. Die Verdrahtung der Stromwandler erfolgt unter Verwendung nachfolgend aufgeführter Anschlussbilder. Beim **Betrieb** des Stromwandlers mit offenem Sekundärkreis, können an den Sekundärklemmen für den Menschen gefährliche Spannungen auftreten. **Ein „offen“-Betrieb des Sekundärkreises von Stromwandlern ist untersagt.** Vor einem Austausch von Messgeräten im Sekundärkreis des Stromwandlers ist dieser an seinen Sekundäranschlüssen kurzzuschließen.

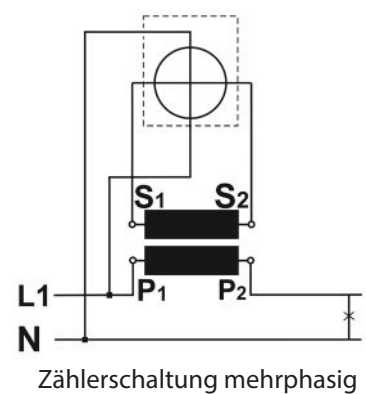
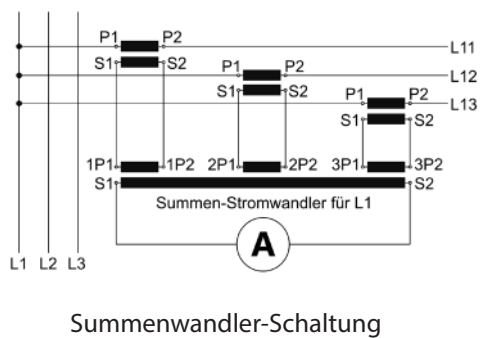
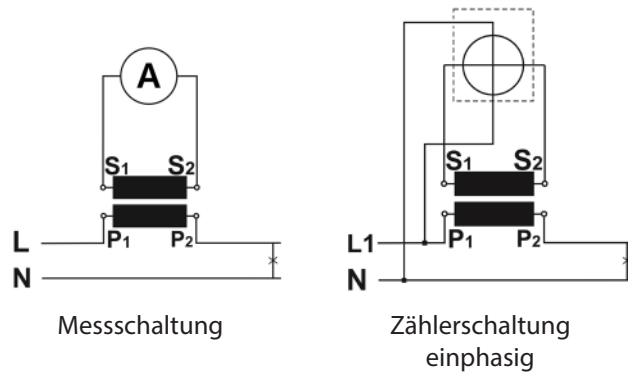

## Fehlergrenzwerte für Messwandler der Klassen 0,2...3 gemäß DIN EN 61869/2 Ausgabe 09/12

Klassengenauigkeit	Stromfehler $\pm \Delta_F$ bei				Fehlwinkel $\pm \Delta_F$ bei			
	$1,2 I_{pr}$	$0,2 I_{pr}$	$0,05 I_{pr}$	$0,01 I_{pr}$	$1,2 I_{pr}$	$0,2 I_{pr}$	$0,05 I_{pr}$	$0,01 I_{pr}$
	$1,0 I_{pr}$				$1,0 I_{pr}$			
	%	%	%	%	min	min	min	min
0,2	0,2	0,35	0,75		10	15	30	
0,2s	0,2	0,2	0,35	0,75	10	10	15	30
0,5	0,5	0,75	1,5		30	45	90	
0,5s	0,5	0,5	0,75	1,5	30	30	45	90
1	1	1,5	3		60	90	180	
3	3*							

\*bei  $0,5 I_{pr}$  und thermischem Nenn-Dauerstrom

## Fehlergrenzwerte der Stromwandler für Schutzzwecke

Klassengenauigkeit	Stromfehler $\pm F_i$ bei		Fehlwinkel $\pm F_i$ bei	
	$1,0 I_{pr}$ und thermischem Nenn-Dauerstrom		$1,0 I_{pr}$ und thermischem Nenn-Dauerstrom	
	%		Minuten	
5 P..	1		60	
10 P..	3			

Gesamtfehler  $F_g$  bei Nenn-Fehlergrenzstrom und Nennbürde Klasse 5P...  $\leq 5\%$   
10P...  $\leq 10\%$

## Strombelastbarkeit von Kupferschienen-Abmessungen und Stromwerte gemäß DIN 43671

Schienenquerschnitt	1 Schiene	2 Schienen	3 Schienen
20 x 10	427 A	825 A	1180 A
30 x 05	379 A	672 A	896 A
30 x 10	573 A	1060 A	1480 A
40 x 05	482 A	836 A	1090 A
40 x 10	715 A	1290 A	1770 A
50 x 10	852 A	1510 A	2040 A
60 x 10	985 A	1720 A	2300 A
80 x 10	1240 A	2110 A	2790 A
100 x 10	1490 A	2480 A	3260 A
Schienenoberfläche		blank	

Vorstehenden Werte gelten für Dauerstrombelastung bei ca. 30°C Umgebungstemperatur

## Bezeichnung der Stromwandler-Anschlussklemmen

Die Anschlüsse aller Primärwicklungen sind mit „P1“ und „P2“ bezeichnet, die Anschlüsse aller Sekundärwicklungen werden mit den entsprechenden Kleinbuchstaben „s1“ und „s2“ bezeichnet.

Bei Stromwandlern mit mehreren Sekundäranzapfungen erhält das Wicklungsende „1“ dann die Beiziffer „11“, die Anzapfungen mit abnehmender Windungszahl die fortlaufende Bezifferung „2“, „3“ etc.

Bei Summen-Stromwandlern mit mehreren Eingangskreisen, werden zu deren eindeutiger Unterscheidung, der üblichen Klemmenbezeichnungen „K“ bzw. „L“, die Großbuchstaben „A“, „B“, „C“ ... vorangestellt.

Bei Summen-Stromwandlern, welche für den Anschluss unterschiedlicher Hauptwandler konzipiert wurden, erfolgt der Anschluss des Hauptwandlers mit dem höchsten Übersetzungsverhältnis, an das am niedrigsten indizierte Klemmenpaar („AK“-„AL“). Die korrekte Anschlusszuordnung kann ebenfalls dem Aufdruck des Leistungsschildes entnommen werden, welches einen Eintrag zum Verhältnis der einzelnen Nennströme der Hauptwandler trägt.

Beispiel:

Hauptwandler 1: 300/5A

Hauptwandler 2: 150/5A

Hauptwandler 3: 100/5A

-> Angabe auf dem Leistungsschild:  $6_A : 3_B : 2_C$

## Fehlerkurven von Niederspannungs-Stromwandlern

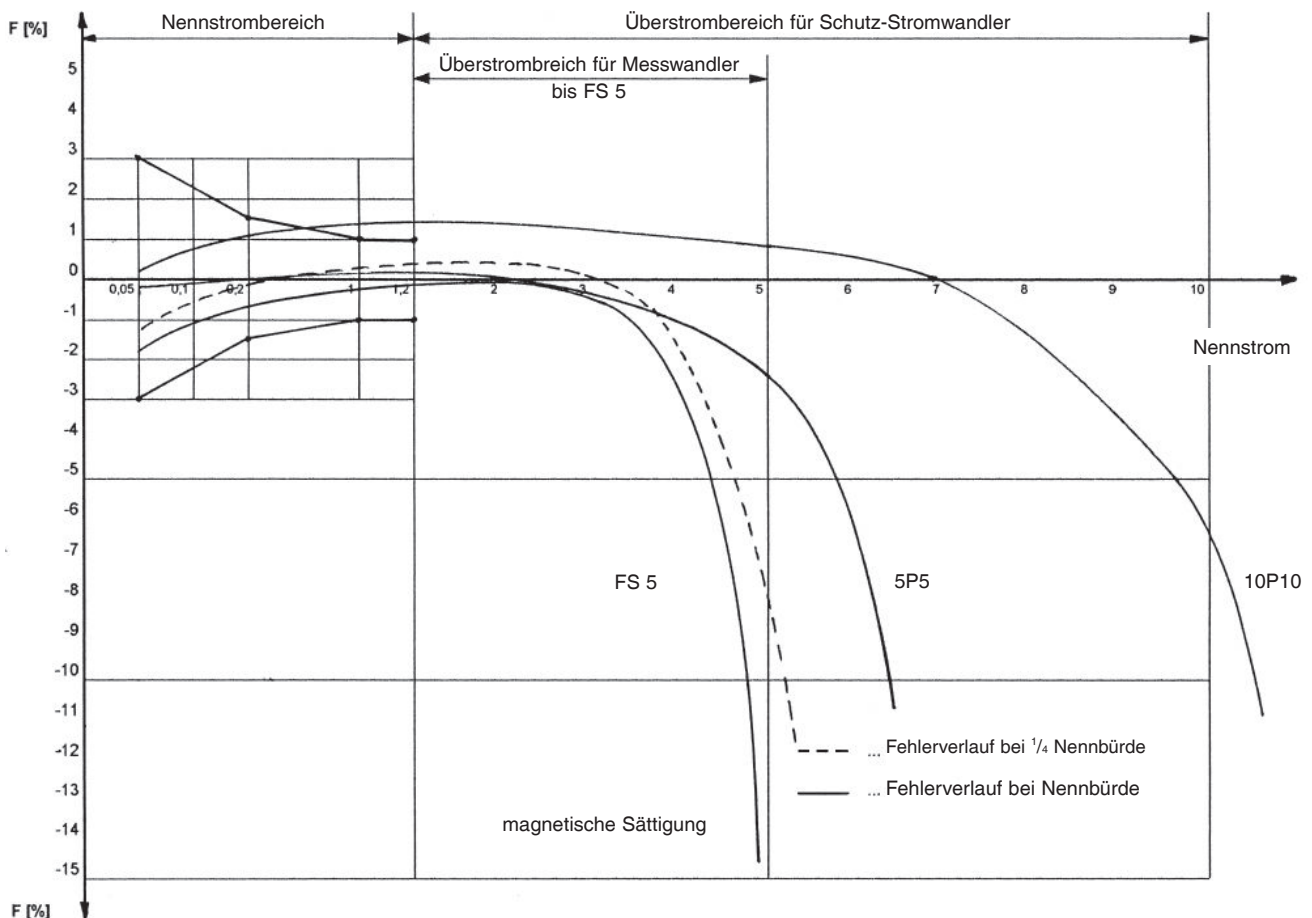

## Leistungsbedarf von Messgeräten und Relais

Beim Einsatz von Stromwandlern werden durch den Anwender folgende zwei Hauptforderungen erhoben:

- hohe Messgenauigkeit im Nennstrombereich
- Schutzfunktion im Überstrombereich

Zur Realisierung dieser Anforderungen ist es notwendig, dass das Leistungsangebot (die Nennscheinleistung) des Stromwandlers, weitestgehend an den tatsächlichen Leistungsbedarf der Messanordnung angepasst wird.

Zur Ermittlung des tatsächlichen Leistungsbedarfs müssen, neben dem Eigenleistungsbedarf der angeschlossenen Messgeräte, auch die Leitungsverluste der an den Sekundärkreis des Wandlers angeschlossenen Messleitungen berücksichtigt werden.

### Eigenleistungsbedarf typischer Messgeräte

Strommesser Weicheisen bis 100 mm Ø	0,700 -	1,5 VA
Gleichrichter-Strommesser	0,001 -	0,25 VA
Vielfach-Strommesser	0,005 -	5,0 VA
Stromschreiber	0,300 -	9,0 VA
Bimetall-Strommesser	2,500 -	3,0 VA
Leistungsmesser	0,200 -	5,0 VA
Leistungsschreiber	3,000 -	12,0 VA
Leistungsfaktormesser	2,000 -	6,0 VA
Leistungsfaktorschreiber	9,000 -	16,0 VA
Zähler	0,400 -	1,0 VA
Relais N-Relais		14,0 VA
Überstrom-Relais	0,200 -	6,0 VA
Überstrom-Zeitrelais	3,000 -	6,0 VA
Richtungsrelais		10,0 VA
Bimetall-Relais	7,000 -	11,0 VA
Distanzrelais	1,000 -	30,0 VA
Differentialrelais	0,200 -	2,0 VA
	1,000 -	15,0 VA
Wandlerstrom-Auslöser	5,000 -	150,0 VA
Regler	5,000 -	180,0 VA

### Eigenverbrauch von Kupferleitungen

$$P_v = \frac{I_s^2 \times 2 \times l}{A_{cu} \times 56} \text{ VA}$$

$I_s$  = Sekundär Bemessungs-Stromstärke [A]  
 $l$  = einfache Leitungslänge in m  
 $A_{cu}$  = Leitungsquerschnitt in mm<sup>2</sup>  
 $P_v$  = Verlustleistung der Anschlussleitungen

Hinweis: Bei gemeinsamer Drehstrom-Rückleitung gelten halbe Werte von  $P_v$

#### Tabelle für Werte bezogen auf 5 A

Nennquerschnitt	1 m	2 m	3 m	4 m	5 m	6 m	7 m	8 m	9 m	10 m
2,5 mm <sup>2</sup>	0,36	0,71	1,07	1,43	1,78	2,14	2,50	2,86	3,21	3,57
4,0 mm <sup>2</sup>	0,22	0,45	0,67	0,89	1,12	1,34	1,56	1,79	2,01	2,24
6,0 mm <sup>2</sup>	0,15	0,30	0,45	0,60	0,74	0,89	1,04	1,19	1,34	1,49
10,0 mm <sup>2</sup>	0,09	0,18	0,27	0,36	0,44	0,54	0,63	0,71	0,80	0,89

#### Tabelle für Werte bezogen auf 1 A

Nennquerschnitt	10 m	20 m	30 m	40 m	50 m	60 m	70 m	80 m	90 m	100 m
1,0 mm <sup>2</sup>	0,36	0,71	1,07	1,43	1,78	2,14	2,50	2,86	3,21	3,57
2,5 mm <sup>2</sup>	0,14	0,29	0,43	0,57	0,72	0,86	1,00	1,14	1,29	1,43
4,0 mm <sup>2</sup>	0,09	0,18	0,27	0,36	0,45	0,54	0,63	0,71	0,80	0,89
6,0 mm <sup>2</sup>	0,06	0,12	0,18	0,24	0,30	0,36	0,42	0,48	0,54	0,60
10,0 mm <sup>2</sup>	0,04	0,07	0,11	0,14	0,18	0,21	0,25	0,29	0,32	0,36

# ASK 615.3

## Aufsteck-Stromwandler



Schiene: 60 x 15 mm  
 Rundleiter: 52 mm  
 Baubreite: 90 mm  
 Bauhöhe: 114,5 mm  
 Bautiefe gesamt: 30 mm

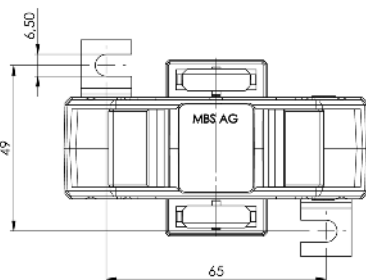
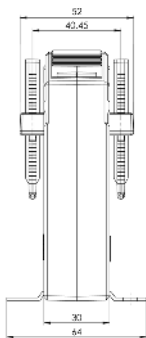
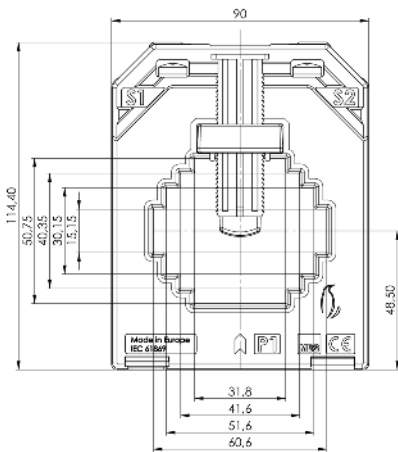

Primärstrom [A]	Bürde [VA]	Sekundärstrom [A] / Klasse				
		5A Kl. 1 Best.-Nr.	5A Kl. 0,5 Best.-Nr.	5A Kl. 0,5s Best.-Nr.	5A Kl. 0,2 Best.-Nr.	5A Kl. 0,2s Best.-Nr.
200	2,5	6153-10000				
250	1		6153-10500			
	2,5	6153-10001				
300	1		6153-10501			
	2,5	6153-10003	6153-10502			
400	1			6153-10600		
	2,5	6153-10006	6153-10503	6153-10601		
	3,75	6153-10007	6153-10504			
	5	6153-10008				
500	2,5	6153-10009	6153-10505	6153-10602		
	5	6153-10010	6153-10506	6153-10603		
600	2,5	6153-10012	6153-10508	6153-10604	6153-10900	
	5	6153-10013	6153-10509	6153-10605		
	7,5	6153-10014	6153-10510			
750	2,5	6153-10015	6153-10511	6153-10607	6153-10901	
	5	6153-10016	6153-10512	6153-10608		
	7,5	6153-10017	6153-10513	6153-10609		
800	2,5	6153-10018	6153-10514	6153-10610	6153-10902	
	5	6153-10019	6153-10515	6153-10611		
	7,5	6153-10020	6153-10516	6153-10612		
1000	2,5		6153-10518		6153-10903	6153-10400
	5	6153-10022	6153-10519	6153-10613	6153-10904	6153-10401
	10	6153-10023	6153-10520	6153-10614	6153-10905	
1250	2,5					6153-10402
	5	6153-10025	6153-10522	6153-10616	6153-10906	6153-10403
	10	6153-10026	6153-10523	6153-10617	6153-10907	
	15	6153-10027	6153-10524	6153-10618	6153-10908	

Inklusive: Fixierschieber für Befestigung auf Stromschiene.

# ASK 615.3



Schiene: 60 x 15 mm  
 Rundleiter: 52 mm  
 Baubreite: 90 mm  
 Bauhöhe: 114,5 mm  
 Bautiefe gesamt: 30 mm

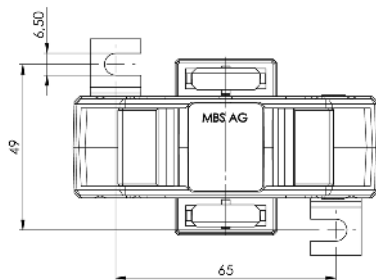
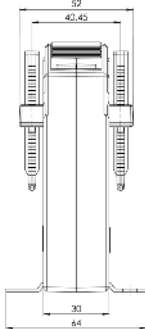
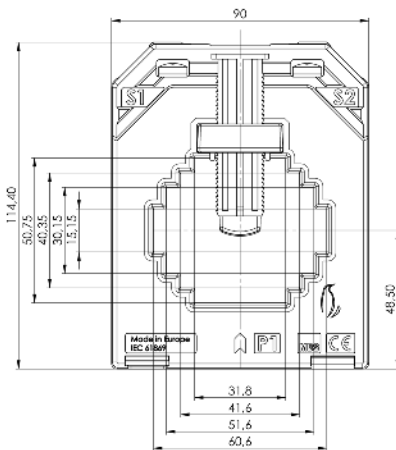

Primärstrom [A]	Bürde [VA]	Sekundärstrom [A] / Klasse				
		5A Kl. 1 Best.-Nr.	5A Kl. 0,5 Best.-Nr.	5A Kl. 0,5s Best.-Nr.	5A Kl. 0,2 Best.-Nr.	5A Kl. 0,2s Best.-Nr.
1500	5	6153-10029	6153-10526	6153-10619	6153-10909	6153-10404
	10	6153-10030	6153-10527	6153-10620	6153-10910	6153-10405
	15	6153-10031	6153-10528	6153-10621		
1600	5	6153-10033	6153-10530	6153-10623	6153-10912	6153-10406
	10	6153-10034	6153-10531	6153-10624	6153-10913	6153-10407
	15	6153-10035	6153-10532	6153-10625	6153-10914	6153-10408

Primärstrom [A]	Bürde [VA]	Sekundärstrom [A] / Klasse				
		1A Kl. 1 Best.-Nr.	1A Kl. 0,5 Best.-Nr.	1A Kl. 0,5s Best.-Nr.	1A Kl. 0,2 Best.-Nr.	1A Kl. 0,2s Best.-Nr.
200	2,5	6153-10200				
250	1					
	2,5	6153-10201	6153-10700			
300	1		6153-10701			
	2,5	6153-10202	6153-10702			
	3,75	6153-10203				
400	1		6153-10703			
	1,25	6153-10220	6153-10719	6153-10800		
	1,5	6153-10221	6153-10720	6153-10813		
	2,5	6153-10204	6153-10704			
	5	6153-10205				
500	2,5	6153-10206	6153-10705	6153-10801		
	3,75		6153-10706			
600	5	6153-10207				
	2,5	6153-10208	6153-10707	6153-10802		
750	5	6153-10209	6153-10708	6153-10803		
	2,5	6153-10210	6153-10709	6153-10804	6153-10300	
	7,5	6153-10211	6153-10710	6153-10805		
800	7,5	6153-10212				
	2,5	6153-10213	6153-10712	6153-10806	6153-10301	
	3,75	6153-10222	6153-10721	6153-10814	6153-10306	
1000	5	6153-10214	6153-10713	6153-10807		
	2,5	6153-10215	6153-10714	6153-10808	6153-10302	6153-10101
	3,75	6153-10223	6153-10722	6153-10815	6153-10307	
1250	5	6153-10216	6153-10715	6153-10809	6153-10303	
	2,5	6153-10217	6153-10716	6153-10810	6153-10304	6153-10100
	3,75	6153-10224	6153-10723	6153-10816	6153-10308	
	5	6153-10218	6153-10717	6153-10811	6153-10305	
	7,5	6153-10219	6153-10718	6153-10812		

Inklusive: Fixierschieber für Befestigung auf Stromschiene.



# ASK 83.3

## Aufsteck-Stromwandler

- Schiene 1: 2 x 80 x 10 mm
- Schiene 2: 3 x 60 x 10 mm
- Schiene 3: 3 x 50 x 10 mm
- Rundleiter: 70 mm
- Baubreite: 106 mm
- Bauhöhe: 132,50 mm
- Bautiefe gesamt: 30 mm

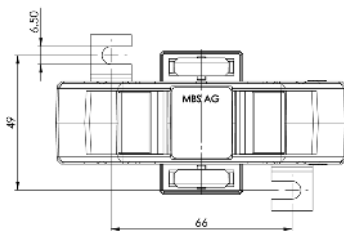
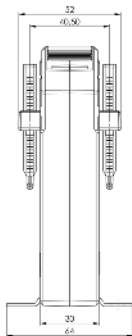
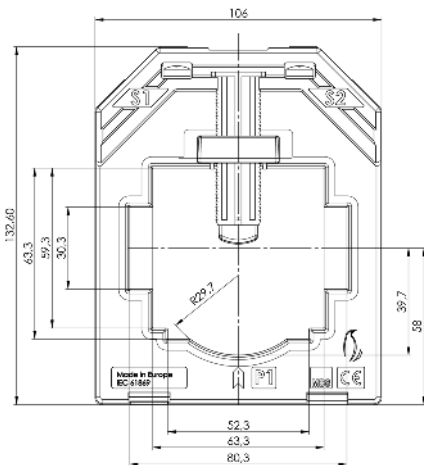

Primärstrom [A]	Bürde [VA]	Sekundärstrom [A] / Klasse				
		5A Kl. 1 Best.-Nr.	5A Kl. 0,5 Best.-Nr.	5A Kl. 0,5s Best.-Nr.	5A Kl. 0,2 Best.-Nr.	5A Kl. 0,2s Best.-Nr.
400	2,5	833-10000	833-10500			
	5	833-10001				
500	2,5	833-10002	833-10502	833-10600		
	5	833-10003	833-10503			
600	2,5	833-10004	833-10504	833-10601		
	5	833-10005	833-10505	833-10602		
	7,5	833-10006	833-10506			
750	2,5	833-10007	833-10507	833-10603		
	5	833-10008	833-10508	833-10604		
	7,5	833-10009	833-10509			
800	2,5	833-10010	833-10510	833-10605	833-10900	
	5	833-10011	833-10511	833-10606		
	7,5			833-10607		
	10	833-10012	833-10512			
1000	2,5	833-10013	833-10513	833-10608	833-10901	
	5	833-10014	833-10514	833-10609	833-10902	
	10	833-10015	833-10515	833-10610		
1250	2,5	833-10016	833-10516	833-10611	833-10903	
	5	833-10017	833-10517	833-10612	833-10904	
	10	833-10018	833-10518	833-10613		
1500	2,5	833-10019	833-10519	833-10614	833-10905	833-10400
	5	833-10020	833-10520	833-10615	833-10906	833-10401
	10	833-10021	833-10521	833-10616	833-10907	
1600	2,5	833-10022	833-10522	833-10617	833-10908	833-10402
	5	833-10023	833-10523	833-10618	833-10909	833-10403
1600	10	833-10024	833-10524	833-10619	833-10910	
	2,5	833-10025	833-10525	833-10620	833-10911	833-10404
2000	5	833-10026	833-10526	833-10621	833-10912	833-10405
	10	833-10027	833-10527	833-10622	833-10913	
	2,5	833-10028	833-10528	833-10623	833-10914	833-10406
2500	5	833-10029	833-10529	833-10624	833-10915	833-10407
	10	833-10030	833-10530	833-10625	833-10916	833-10408
	15	833-10031	833-10531	833-10626	833-10917	
	2,5					

Inklusive: Fixierschieber für Befestigung auf Stromschiene.

# ASK 83.3



- Schiene 1: 2 x 80 x 10 mm
- Schiene 2: 3 x 60 x 10 mm
- Schiene 3: 3 x 50 x 10 mm
- Rundleiter: 70 mm
- Baubreite: 106 mm
- Bauhöhe: 132,50 mm
- Bautiefe gesamt: 30 mm

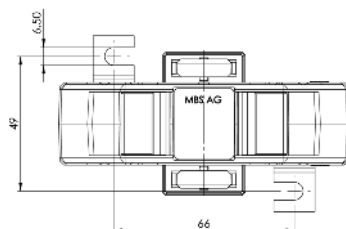
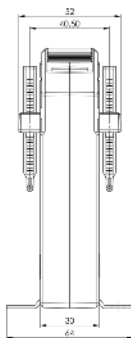
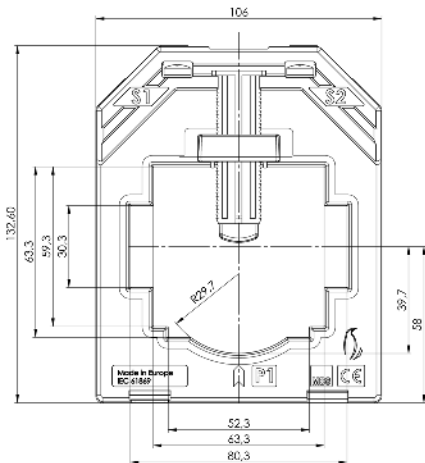

Primärstrom [A]	Bürde [VA]	Sekundärstrom [A] / Klasse				
		1A Kl. 1 Best.-Nr.	1A Kl. 0,5 Best.-Nr.	1A Kl. 0,5s Best.-Nr.	1A Kl. 0,2 Best.-Nr.	1A Kl. 0,2s Best.-Nr.
500	2,5	833-10200	833-10700			
	5	833-10201				
600	2,5	833-10202	833-10701	833-10800		
	5	833-10203	833-10702			
750	2,5	833-10204	833-10703	833-10801		
	5	833-10205	833-10704	833-10802		
	7,5	833-10206	833-10705			
800	2,5	833-10207	833-10706	833-10803	833-10300	
	5	833-10208	833-10707	833-10804		
	7,5	833-10209	833-10708			
1000	2,5	833-10210	833-10709	833-10805	833-10301	
	5	833-10211	833-10710	833-10806		
	10	833-10212	833-10711			
1250	2,5	833-10213	833-10712	833-10807	833-10302	
	5	833-10214	833-10713	833-10808	833-10303	
	10	833-10215	833-10714	833-10809		
1500	2,5	833-10216	833-10715	833-10810	833-10304	833-10100
	5	833-10217	833-10716	833-10811	833-10305	
	10	833-10218	833-10717	833-10812	833-10306	
1600	2,5	833-10219	833-10718	833-10813	833-10307	833-10101
	5	833-10220	833-10719	833-10814	833-10308	
	10	833-10221	833-10720	833-10815	833-10309	

Inklusive: Fixierschieber für Befestigung auf Stromschiene.



# ASK 105.3

## Aufsteck-Stromwandler

Schiene: 100 x 56 mm  
 Baubreite: 129 mm  
 Bauhöhe: 156 mm  
 Bautiefe gesamt: 30 mm

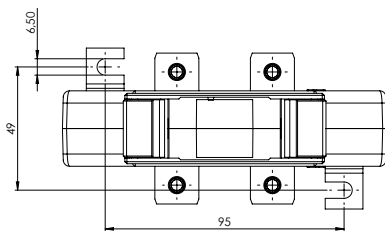
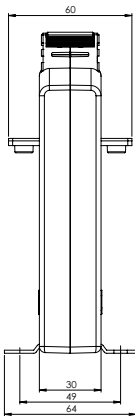
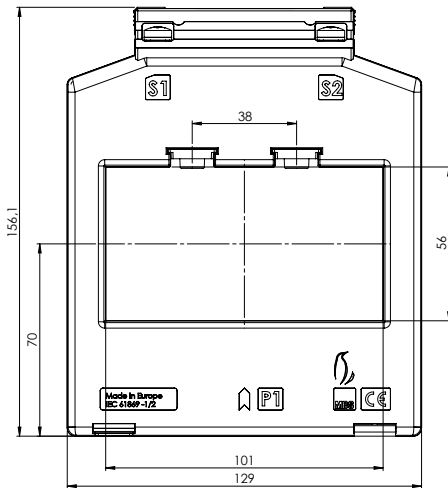

Primärstrom [A]	Bürde [VA]	Sekundärstrom [A] / Klasse				
		5A Kl. 1 Best.-Nr.	5A Kl. 0,5 Best.-Nr.	5A Kl. 0,5s Best.-Nr.	5A Kl. 0,2 Best.-Nr.	5A Kl. 0,2s Best.-Nr.
400	2,5	1053-10000				
	3,75	1053-10001				
	5	1053-10002				
500	2,5	1053-10003	1053-10500			
	3,75	1053-10004	1053-10501			
	5	1053-10005	1053-10502			
600	2,5	1053-10006	1053-10503			
	3,75	1053-10007	1053-10504			
	5	1053-10008	1053-10505			
	7,5	1053-10009				
750	2,5	1053-10011	1053-10506	1053-10600		
	3,75	1053-10012	1053-10507			
	5	1053-10013	1053-10508			
	7,5	1053-10014				
	10	1053-10015				
800	2,5	1053-10016	1053-10509	1053-10601		
	5	1053-10017	1053-10510			
	7,5	1053-10018	1053-10511			
	10	1053-10019				
1000	2,5	1053-10020	1053-10512	1053-10602		
	5	1053-10021	1053-10513	1053-10603		
	7,5	1053-10022	1053-10514	1053-10604		
	10	1053-10023	1053-10515	1053-10605		
1250	2,5	1053-10024	1053-10516	1053-10606		
	5	1053-10025	1053-10517	1053-10607		
	10	1053-10026	1053-10518	1053-10608		
	15	1053-10027				
1500	2,5	1053-10028	1053-10520	1053-10609	1053-10905	
	5	1053-10029	1053-10521	1053-10610	1053-10906	
	10	1053-10030	1053-10522	1053-10611	1053-10907	
	15	1053-10031	1053-10523	1053-10612		
1600	2,5	1053-10032	1053-10524	1053-10613	1053-10908	
	5	1053-10033	1053-10525	1053-10614	1053-10909	
	10	1053-10034	1053-10526	1053-10615	1053-10910	
	15	1053-10035	1053-10527	1053-10616		
2000	2,5	1053-10036	1053-10528	1053-10617	1053-10911	1053-10400
	5	1053-10037	1053-10529	1053-10618	1053-10912	1053-10401
	7,5	1053-10038	1053-10530	1053-10619	1053-10913	
	10	1053-10039	1053-10531	1053-10620	1053-10914	
	15	1053-10040	1053-10532	1053-10621		

# ASK 105.3



Schiene: 100 x 56 mm  
 Baubreite: 129 mm  
 Bauhöhe: 156 mm  
 Bautiefe gesamt: 30 mm

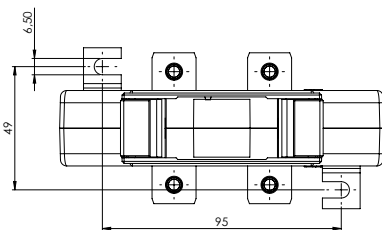
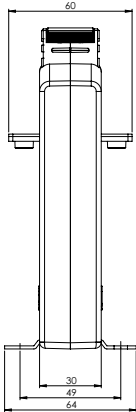
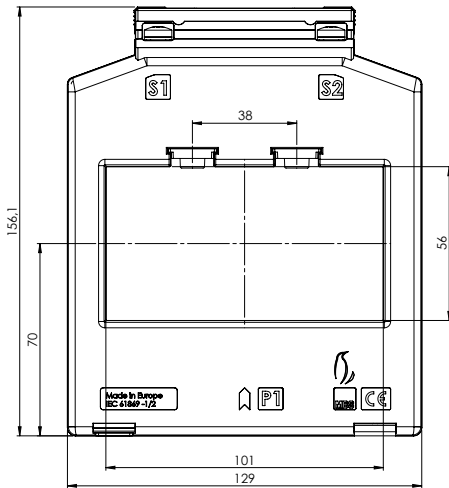

Primärstrom [A]	Bürde [VA]	Sekundärstrom [A] / Klasse				
		5A Kl. 1 Best.-Nr.	5A Kl. 0,5 Best.-Nr.	5A Kl. 0,5s Best.-Nr.	5A Kl. 0,2 Best.-Nr.	5A Kl. 0,2s Best.-Nr.
2500	2,5			1053-10622	1053-10916	1053-10402
	5	1053-10041	1053-10533	1053-10623	1053-10917	1053-10403
	7,5	1053-10042	1053-10534	1053-10624	1053-10918	1053-10404
	10	1053-10043	1053-10535	1053-10625	1053-10919	1053-10405
	15	1053-10044	1053-10536	1053-10626	1053-10920	
3000	5	1053-10045	1053-10537	1053-10627	1053-10921	1053-10406
	10	1053-10046	1053-10538	1053-10628	1053-10922	1053-10407
	15	1053-10047	1053-10539	1053-10629	1053-10923	1053-10408
4000	2,5	1053-10048				
	5	1053-10049	1053-10540	1053-10630	1053-10924	1053-10409
	10	1053-10050	1053-10541	1053-10631	1053-10925	1053-10410
	15	1053-10051	1053-10542	1053-10632	1053-10926	1053-10411

Primärstrom [A]	Bürde [VA]	Sekundärstrom [A] / Klasse				
		1A Kl. 1 Best.-Nr.	1A Kl. 0,5 Best.-Nr.	1A Kl. 0,5s Best.-Nr.	1A Kl. 0,2 Best.-Nr.	1A Kl. 0,2s Best.-Nr.
400	2,5	1053-10200				
	3,75	1053-10201				
	5	1053-10202				
500	2,5	1053-10203	1053-10700			
	3,75	1053-10204	1053-10701			
	5	1053-10205	1053-10702			
600	2,5	1053-10206	1053-10703			
	3,75	1053-10207	1053-10704			
	5	1053-10208	1053-10705			
	7,5	1053-10209				
	10	1053-10210				
750	2,5	1053-10211	1053-10706	1053-10800		
	3,75	1053-10212	1053-10707			
	5	1053-10213	1053-10708			
	7,5	1053-10214				
	10	1053-10215				
800	2,5	1053-10216	1053-10709	1053-10801		
	5	1053-10217	1053-10710			
	7,5	1053-10218				
	10	1053-10219				
1000	2,5	1053-10220	1053-10711	1053-10802	1053-10300	
	5	1053-10221	1053-10712	1053-10803	1053-10301	
	7,5	1053-10222	1053-10713	1053-10804		
	10	1053-10223	1053-10714	1053-10805		
1250	2,5	1053-10224	1053-10715	1053-10806	1053-10302	
	5	1053-10225	1053-10716	1053-10807	1053-10303	
	10	1053-10226	1053-10717	1053-10808		
	15	1053-10227	1053-10718			

# ASK 105.3



Schiene: 100 x 56 mm  
 Baubreite: 129 mm  
 Bauhöhe: 156 mm  
 Bautiefe gesamt: 30 mm

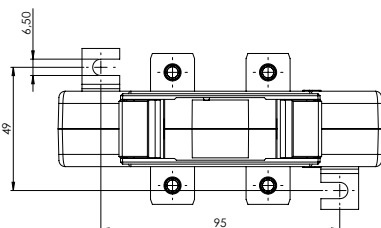
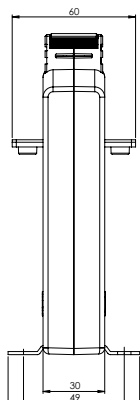
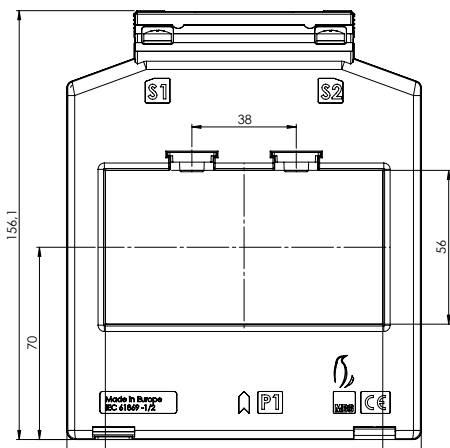

Primärstrom [A]	Bürde [VA]	Sekundärstrom [A] / Klasse				
		1A Kl. 1 Best.-Nr.	1A Kl. 0,5 Best.-Nr.	1A Kl. 0,5s Best.-Nr.	1A Kl. 0,2 Best.-Nr.	1A Kl. 0,2s Best.-Nr.
1500	2,5	1053-10228	1053-10719	1053-10809	1053-10304	
	5	1053-10229	1053-10720	1053-10810	1053-10305	
	10	1053-10230	1053-10721	1053-10811	1053-10306	
	15	1053-10231	1053-10722	1053-10812		
1600	2,5	1053-10232	1053-10723	1053-10813	1053-10307	
	5	1053-10233	1053-10724	1053-10814	1053-10308	
	10	1053-10234	1053-10725	1053-10815	1053-10309	
	15	1053-10235	1053-10726	1053-10816		
2000	2,5	1053-10236	1053-10727	1053-10817	1053-10310	1053-10100
	5	1053-10237	1053-10728	1053-10818	1053-10311	1053-10101
	7,5	1053-10238	1053-10729	1053-10819	1053-10312	
	10	1053-10239	1053-10730	1053-10820	1053-10313	
	15	1053-10240	1053-10731	1053-10821	1053-10314	
2500	2,5	1053-10241	1053-10732	1053-10822	1053-10315	1053-10102
	5	1053-10242	1053-10733	1053-10823	1053-10316	1053-10103
	7,5	1053-10243	1053-10734	1053-10824	1053-10317	1053-10104
	10	1053-10244	1053-10735	1053-10825	1053-10318	1053-10105
	15	1053-10245		1053-10826	1053-10319	
3000	5	1053-10246	1053-10736	1053-10827	1053-10320	1053-10106
	10	1053-10247	1053-10737	1053-10828	1053-10321	1053-10107
	15	1053-10248	1053-10738	1053-10829	1053-10322	

# ASK 127.3

## Aufsteck-Stromwandler



Schiene: 122 x 71 mm  
 Baubreite: 159 mm  
 Bauhöhe: 188 mm  
 Bautiefe gesamt: 30 mm

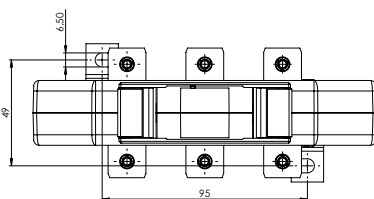
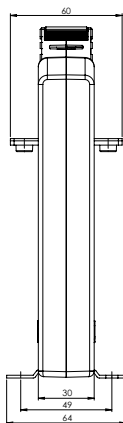
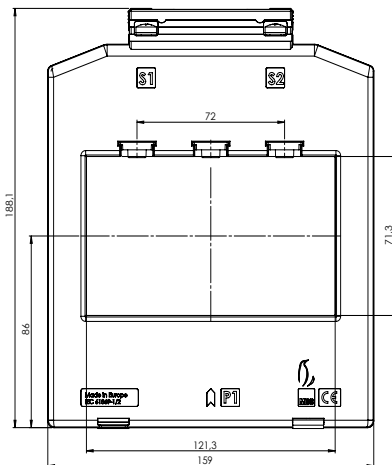

Primärstrom [A]	Bürde [VA]	Sekundärstrom [A] / Klasse				
		5A Kl. 1 Best.-Nr.	5A Kl. 0,5 Best.-Nr.	5A Kl. 0,5s Best.-Nr.	5A Kl. 0,2 Best.-Nr.	5A Kl. 0,2s Best.-Nr.
400	2,5	1273-10000				
	3,75	1273-10001				
	5	1273-10002				
	7,5					
500	10					
	2,5	1273-10003	1273-10500			
	3,75	1273-10004	1273-10501			
	5	1273-10005				
600	10					
	2,5	1273-10006	1273-10502			
	3,75	1273-10007	1273-10503			
	5	1273-10008	1273-10504			
750	10	1273-10009				
	2,5	1273-10010	1273-10505			
	3,75	1273-10011	1273-10506			
	5	1273-10012	1273-10507			
	7,5	1273-10013	1273-10508			
800	10	1273-10014	1273-10509			
	2,5	1273-10015	1273-10510			
	3,75	1273-10016	1273-10511			
	5	1273-10017	1273-10512			
	7,5	1273-10018	1273-10513			
1000	10	1273-10019	1273-10514			
	2,5	1273-10020	1273-10515			
	5	1273-10021	1273-10516			
	7,5	1273-10022	1273-10517			
	10	1273-10023	1273-10518			
1250	15	1273-10024	1273-10519			
	2,5	1273-10025	1273-10520			
	5	1273-10026	1273-10521			
	10	1273-10027	1273-10522			
1500	15	1273-10028	1273-10523			
	2,5	1273-10029	1273-10524			
	5	1273-10030	1273-10525	1273-10600		
	10	1273-10031	1273-10526	1273-10601		
1600	15	1273-10032	1273-10527			
	2,5	1273-10033	1273-10528			
	5	1273-10034	1273-10529	1273-10602		
	10	1273-10035	1273-10530	1273-10603		
1600	15	1273-10036	1273-10531			

# ASK 127.3



Schiene: 122 x 71 mm  
 Baubreite: 159 mm  
 Bauhöhe: 188 mm  
 Bautiefe gesamt: 30 mm

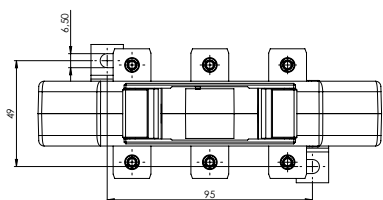
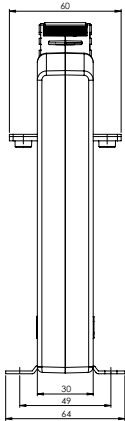
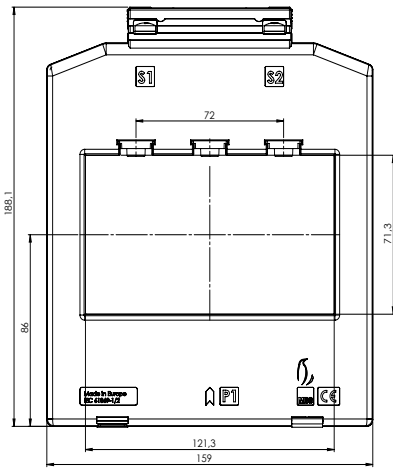

Primärstrom [A]	Bürde [VA]	Sekundärstrom [A] / Klasse				
		5A Kl. 1 Best.-Nr.	5A Kl. 0,5 Best.-Nr.	5A Kl. 0,5s Best.-Nr.	5A Kl. 0,2 Best.-Nr.	5A Kl. 0,2s Best.-Nr.
2000	2,5	1273-10037	1273-10532			
	5	1273-10038	1273-10533	1273-10604	1273-10900	
	10	1273-10039	1273-10534	1273-10605	1273-10901	
	15	1273-10040	1273-10535	1273-10606		
2500	2,5	1273-10041	1273-10536			
	5	1273-10042	1273-10537	1273-10607	1273-10902	1273-10400
	10	1273-10043	1273-10538	1273-10608	1273-10903	
	15	1273-10044	1273-10539	1273-10609		
3000	2,5	1273-10045	1273-10540			
	5	1273-10046	1273-10541	1273-10610	1273-10904	1273-10401
	10	1273-10047	1273-10542	1273-10611	1273-10905	1273-10402
	15	1273-10048	1273-10543	1273-10612	1273-10906	
4000	5	1273-10049	1273-10544	1273-10613	1273-10907	1273-10403
	10	1273-10050	1273-10545	1273-10614	1273-10908	1273-10404
	15	1273-10051	1273-10546	1273-10615	1273-10909	1273-10405

Primärstrom [A]	Bürde [VA]	Sekundärstrom [A] / Klasse				
		1A Kl. 1 Best.-Nr.	1A Kl. 0,5 Best.-Nr.	1A Kl. 0,5s Best.-Nr.	1A Kl. 0,2 Best.-Nr.	1A Kl. 0,2s Best.-Nr.
400	2,5	1273-10200				
	3,75	1273-10201				
	5	1273-10202				
	7,5					
	10					
500	2,5	1273-10203	1273-10700			
	3,75	1273-10204				
	5	1273-10205				
	10	1273-10206				
600	2,5	1273-10207	1273-10701			
	3,75	1273-10208	1273-10702			
	5	1273-10209	1273-10703			
	10	1273-10210				
750	2,5	1273-10211	1273-10704			
	3,75	1273-10212	1273-10705			
	5	1273-10213	1273-10706			
	7,5					
	10					
800	2,5	1273-10214	1273-10707			
	3,75	1273-10215	1273-10708			
	5	1273-10216	1273-10709			
	7,5	1273-10217				
	10	1273-10218				

# ASK 127.3



Schiene: 122 x 71 mm  
 Baubreite: 159 mm  
 Bauhöhe: 188 mm  
 Bautiefe gesamt: 30 mm

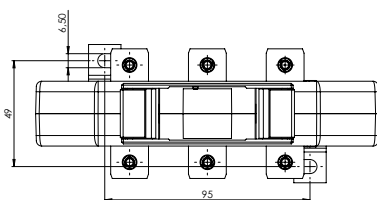
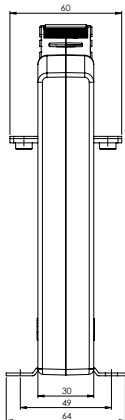
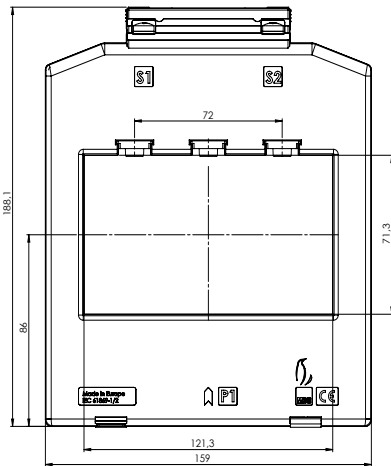

ASK 127.3		Sekundärstrom [A] / Klasse				
Primärstrom [A]	Bürde [VA]	1A Kl. 1 Best.-Nr.	1A Kl. 0,5 Best.-Nr.	1A Kl. 0,5s Best.-Nr.	1A Kl. 0,2 Best.-Nr.	1A Kl. 0,2s Best.-Nr.
1000	2,5	1273-10219	1273-10710			
	5	1273-10220	1273-10711			
	7,5	1273-10221	1273-10712			
	10	1273-10222	1273-10713			
	15	1273-10223				
1250	2,5	1273-10224	1273-10714			
	5	1273-10225	1273-10715			
	10	1273-10226	1273-10716			
	15	1273-10227	1273-10717			
1500	2,5	1273-10228	1273-10718			
	5	1273-10229	1273-10719	1273-10800		
	10	1273-10230	1273-10720	1273-10801		
	15	1273-10231	1273-10721			
1600	2,5	1273-10232	1273-10722			
	5	1273-10233	1273-10723	1273-10802		
	10	1273-10234	1273-10724	1273-10803		
	15	1273-10235	1273-10725			
2000	2,5	1273-10236	1273-10726			
	5	1273-10237	1273-10727	1273-10804	1273-10300	
	10	1273-10238	1273-10728	1273-10805	1273-10301	
	15	1273-10239	1273-10729	1273-10806		
2500	2,5	1273-10240	1273-10730			
	5	1273-10241	1273-10731	1273-10807	1273-10302	1273-10100
	10	1273-10242	1273-10732	1273-10808	1273-10303	
	15	1273-10243	1273-10733	1273-10809		
3000	2,5	1273-10244	1273-10734			
	5	1273-10245	1273-10735	1273-10810	1273-10304	1273-10101
	10	1273-10246	1273-10736	1273-10811	1273-10305	1273-10102
4000	15	1273-10247	1273-10737	1273-10812	1273-10306	
	5	1273-10248	1273-10738	1273-10813	1273-10307	1273-10103
	10	1273-10249	1273-10739	1273-10814	1273-10308	1273-10104
	15	1273-10250	1273-10740	1273-10815	1273-10309	1273-10105

**Energie. Zuverlässig. Messen.**



**MBS AG & Co. KG**

Eisbachstraße 51 | 74429 Sulzbach-Laufen  
Deutschland

Tel.: +49 07976 / 9851-0

Fax: +49 07976 / 9851-90

info@mbs-ag.com | www.mbs-ag.com



**Folgen Sie uns**



@mbsfirma



mbs ag



your.mbsag